

Data Sheet



Article number: 03707022

Description: Fluro rod end BRF 22 L
threaded left with ball bearing

Measures

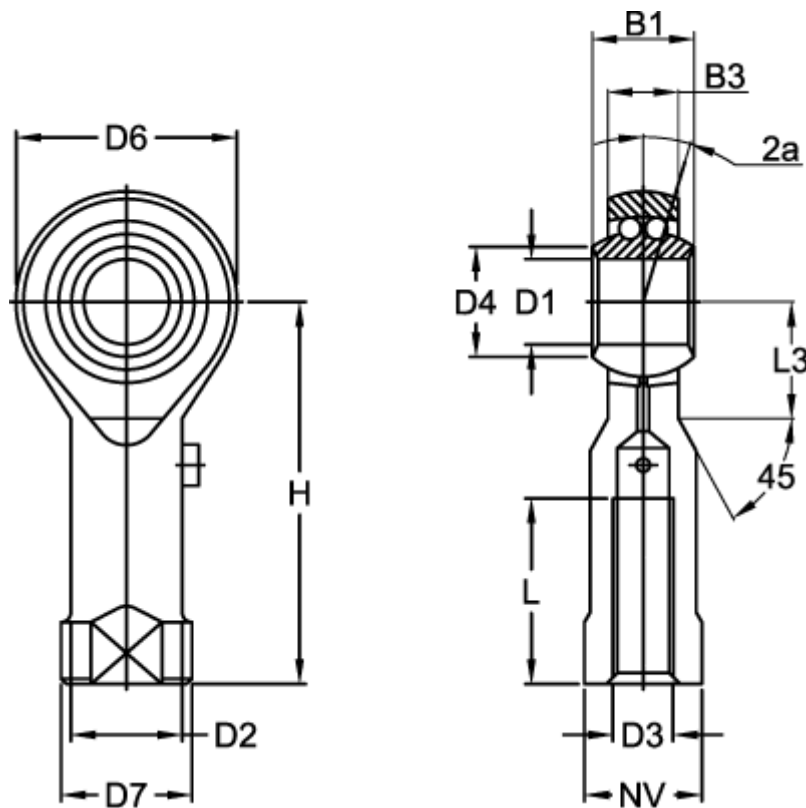

Angel 2a = 8.0	D7 = 38
B1 = 28	Dynamic load C (N) = 9300
B3 = 20.00	H = 84
D1 = 22	L = 37
D2 = 30.0	L3 = 26
D3 = M22x1,5	Max rpm = 725
D4 = 26.0	NV = 32
D6 = 54	Static load (N) = 3980

Weight (kg) = 0.480